

Accessories

Standard : ● Optional : ★

Item	Model	HCMC-1100	HCMC-1365	HCMC-1370	HCMC-1682	HCMC-2082	HCMC-2110
1.Full-enclosed splash guard		●	●	●	●	●	●
2.Cooling System		●	●	●	●	●	●
3.Lubrication system		●	●	●	●	●	●
4.Two side chip of the chassis (screw type)		★	●	●	●	●	●
5.Coolant Tank (With Chip Bucket)		●	●	●	●	●	●
6.Operation Manual & Electric Drawing Equipment		●	●	●	●	●	●
7.Fluorescent lampx1		●	●	●	●	●	-
8.Air blast through spindle		●	●	●	●	●	●
9.Leveling Bolts and Blocks		●	●	●	●	●	●
10.Remote manual pulse generator		●	●	●	●	●	●
11.Convection Heat Exchanger in Control		●	●	●	●	●	●
12.Auto Power off		●	●	●	●	●	●
13.Operation Finish Lamp		●	●	●	●	●	●
14.RS232 Interface		●	●	●	●	●	●
15.Tool Package		●	●	●	●	●	●
16.Operator Panel. Pendent type		-	●	●	●	●	●
17.Spray around spindle		●	●	●	●	●	●
18.#50 Disk Type Tool Magazine		●	●	●	●	●	●
19Spindle Oil Cooler		●	●	●	●	●	●
20.Coolant Through Spindle_20BAR Without Water Cart		★	★	★	★	★	★
21.Coolant Through Spindle_25BAR Without Water Cart		★	★	★	★	★	★
22.Coolant Through Spindle Preparation Only		★	★	★	★	★	★
23.Closed Loop Linear Scale Positioning System		★	★	★	★	★	★
24.AUTO tool length and diameter measurement		★	★	★	★	★	★
25.Oil Mist Collector System		★	★	★	★	★	★
26.Fluorescent Lampx2		★	★	★	★	★	●
27.NC Rotary Table		★	★	★	★	★	★
28.DNC Software		★	★	★	★	★	★
29. 90° Angle Head(Tool Type)		-	-	★	★	★	★
30. Link type chip conveyor& portable chip bucket		★	★	★	★	★	★
31. Spindle Oil Cooler(only Pulley/Gear8000rpm)		★	★	★	★	★	★
32. Auto Work Piece Measurement		★	★	★	★	★	★
33. Coolant flushing Device		★	★	★	★	★	★
34. Water gun		★	★	★	★	★	★
35. Air gun		★	★	★	★	★	★
36. Oil skimmer		★	★	★	★	★	★
37. Operation Finish Lamp		★	★	★	★	★	★



Intelligent Machining Center

HCMC Series Smartcenter

- Hartrol Premium controller
- 5-Year warranty on guideways
- Z-axis column oversized design
- Spindle run-out : 10 micro
- 8,000 rpm gear type spindle



Hartrol Premium®
From tradition to intelligent



She Hong INDUSTRIAL CO. LTD.

No.3 Jingke N. Road, Taichung City, 408 Taiwan
www.hartford.com.tw Tel: 886-4-23501980
Fax: 886-4-23581793 CAT.No.: 20220428- E20
All Graphic and text on the catalog have been registered. Those who reprint will be held liable

Website



Facebook



Hartford

Hartrol · Smartcenter · Robocell

We manufacture intelligent machines only

A.I. Applications inside, Hartrol Premium is the control which provides machining status with advanced features.

Imagine what future machines ought to be outlined.







AiSmartcontrol



Hartford redefine the future



Major functions of Hartford AI controller

- 
 Facial Recognition system-Face ID
- 
 AI Environment Thermal Displacement Compensation
- 
 AI Efficient Lubrication Management
- 
 Broken Tool Detection System
- 
 Highlight on Intelligent Auger
- 
 AI Navi

IoT

- + Remote Warm-up & Turn-on
- + Hartrol Plus Sync & Update
- + User Connect



Thermal stability solution

- + Spindle Thermal Compensation
- + Casting Thermal Compensation
- + Thermal Symmetry / Thermal Balancing



ZDT

- + Diagnosis Report on Spindle Operation
- + Alarm Report System



AI

- + Facial Recognition System
- + AI Efficient Lubrication Management
- + Smart Efficient Chip Collection



How to quickly implement automation?

Hartford Robot Production Cell

Easy to get started

Hartford Robocell provides you a professional robot training and rich automation experience, to let you quickly learn and easily operate your automation systems

Quality control monitoring

Automation systems have to pass all the strict Quality Control tests at every stage like design, assembly, testing, final inspection and shipment, complete quality control processes for all the products.

Professional analysis

Robocell Machining optimization service, to let you be on the top by using professional machining methods

What definition of Automation interface only :



- 1. Automatic Door
- 2. Automatic Interface
- 3. Pneumatic/ Hydraulic Interface
- 4. Other options

1. Automatic Door

- Pneumatic/Automatic Door System_Operating Door
- Pneumatic/ Servo Automatic Door System_Right Side Door

2. Automatic Interface

- I/O Preparation
- Profibus Link Preparation
- CC-Link Preparation
- EtherNet/IP Link Preparation

3. Pneumatic/ Hydraulic Interface

- 1/2/3 Cell Automatic Pneumatic/ Hydraulic Interface in the machine

4. Other options

- High Pressure Spray Nozzle with Automatic Preparation
- HStainless Base
- High-volume chip-removal system comprising dual side augers

Versatile Machining for Industry

A perfect demonstration for machining accuracy and ability.

The Super Tornado offers incredible versatility for you workshop, combining high efficiency material removal for large workpiece to super fine finishing on small automotive components. The Super Tornado covers a huge range of requirements delivering excellent surface finish and the very latest operational features backed by the Hartford brand.



1. Honeycomb structural component



2. Mechanical part

Actual cutting tests

Model : HCMC-1100

■ Spindle : 6,000 rpm #50 Gear type 18.5kW ■ Cutting material : S45C



Face milling

Tool diameter Ø125 mm
 Feed rate 1,800 mm/min
 Cutting depth 3 mm
 Cutting Width 100mm
 Cutting volume 540 cc



End milling

Tool diameter Ø63 mm
 Feed rate 4,000mm/min
 Cutting depth 30 mm
 Cutting Width 4 mm
 Cutting volume 600 cc



Tapping

Tool diameter Ø42mm
 Feed rate 315 mm/min
 Cutting depth 42mm



Drilling

Tool diameter Ø50 mm
 Feed rate 250 mm/min
 Cutting depth 50mm

Model : HCMC-1682

■ Spindle : 6,000 rpm #50 Gear type 26kW ■ Cutting material : S45C



Face milling

Tool diameter Ø125 mm
 Feed rate 2,400 mm/min
 Cutting depth 3 mm
 Cutting Width 100 mm
 Cutting volume 720 cc



End milling

Tool diameter Ø63 mm
 Feed rate 3,000mm/min
 Cutting depth 40 mm
 Cutting Width 5 mm
 Cutting volume 600 cc



Tapping

Tool diameter Ø42 mm
 Feed rate 360 mm/min
 Cutting depth 50 mm



Drilling

Tool diameter Ø76 mm
 Feed rate 100 mm/min
 Cutting depth 50 mm

All the results featured in this catalogue were produced under strict testing condition in a special zed testing environment. Under different testing conditions and in less than ideal testing environments. That the test results may vary from those shown in this catalogue.

The very first step for fully intelligent machining.

Hartford APP Store

What is Hartrol Premium?

Hartrol premium is a brand new intelligent controller Hartrol , Hartnet and Hartford electrical function together which developed and made by Hartford.

HMI and operation is user friendly, it can achieve :

1. Internet connection, collect and analyze data, monitoring by portable device
2. Intelligent control: Auto revise human error and operating basis
3. Real time update new APPs

The difference between Hartrol plus and others

Function	Hartrol Premium	Others
Screen Size	19" Multi-touch Panel	10.4" (OPT:15")
Look Ahead Block	2700(G5P20000)	400(1000 Max.)
Hard Drive	32GB SSD	NO
Smoothing Interpolation	SSS 4G	Option
Industry 4.0	Hartford UserConnect	NO



The main technologies of Hartford smartcenter include intelligent managing system, status monitoring, alarm predicting, machine status diagnosis, crash preventing, 3D program simulation, machining efficiency improving...etc. All the intelligent functions help you control the machine status and assure the job quality.



The Intelligent Controller You Should Have

With three major solutions, Hartrol Plus takes you machining to the next level. Highly optimized and intelligent controls bring even more capabilities and productivity to your metal cutting processes. With ease use, advanced automation, and smart data collection, Hartrol plus is essential tool for enhancing performance on your production floor.

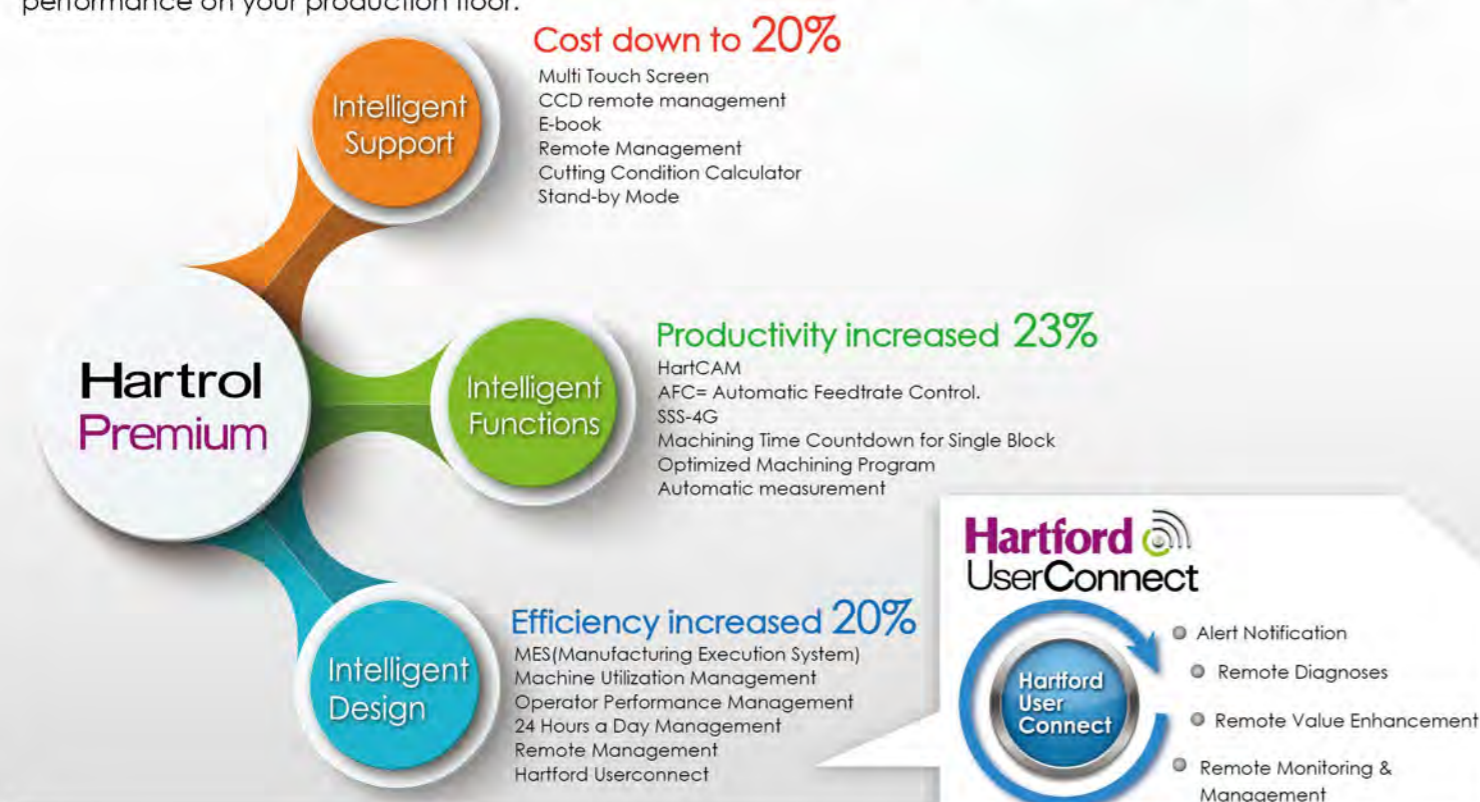

Hartford smartcenter APP



The fuctions mentioned above will need to option the Hartrol plus controller or Dual screen with Fanuc controller.

What Hartford APP can do for you?

The integrated intelligent functions of Hartrol plus could achieve your machining requirements.
 For more Hartrol Plus functions, please contact our sales person.

AI Environment Thermal Displacement Compensation(opt.)

Vertical machining center : **0.03mm**
 Thermal displacement problem is improved up to **60%**
 It can achieve good accuracy as in constant temperature room.



AI Facial recognition system(opt.)

Face ID log-in authority
 Recognition time: **2 seconds**
 Recognition accuracy: **100%**



Highlight on Intelligent Auger(opt.)

50% efficacy increases

- Intelligent auger automatically proceeds cleaning iron chips based on electrical current of spindle.
- Intelligent auger automatically performing reversal mode in case amount of iron chips outnumbers, preventing from machine stop. Auger is overly shielded



AI Efficient Lubrication Management(opt.)

50% lubrication saved.

- Auto-adjustment oil supply base on machining condition.
- 50% oil consumption saved



On line update

With online updating system similar to smart phone will make sure your operating system stays the latest version with Hartford.

- 24hr ➡ Live updating , no boundary no time zone difference.
- NEW ➡ Synchronize with Hartford for the latest information and functions.
- Easy ➡ One key updating, easy and fast !



The Hartrol plus NC version must be A6 or above



Graphical user interfaces for part setting, inspection, tool setting

- Ease of use
- Increasing usability
- Eliminating manual set-up tasks
- Increasing efficiency



Hartford ZDT

Eliminate machine down time and increase efficiency. ZDT –

- Ease of use
- Check parts status clearly
- Eliminating unexpected down time
- Instand notification to your machine and your portable device



AFC(opt.)

Machining efficiency is increased by **21%**↑
 Controls the feed rate depending on the machining situation

- Adjusting feed rate automatically
- Lengthen your tool life
- Reduce machining time

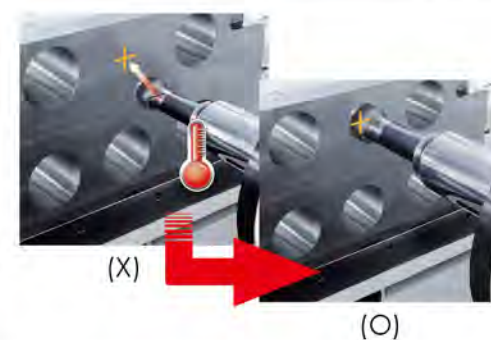

Thermal compensation on spindle(opt.)

No worries about HEAT!!

- Machine with compensation
 - #40 spindle thermal extension is within 0.03mm
 - #50 spindle thermal extension is within 0.02mm
 - Machine without compensation
 - Spindle thermal extension is around 0.10mm
- Notes: Above test is under room temperature



Unlimited Cutting from Hartford Super Tornado

Hartford Super Tornado delivers massive cutting versatility to your workshop. Whether you need heavy cutting or fine finishing the incredible structural stability and cutting performance of HCMC series will exceed your expectations.



Optimum stability for maximum support – High rigidity structure

Vibration damping is key to machining hard materials whilst machining tolerance and cycle times that you need. HCMC series structure is specially designed cast iron (Meehanite), that is heavily ribbed and reinforced to absorb those vibrations and maintain the surface finish you need.

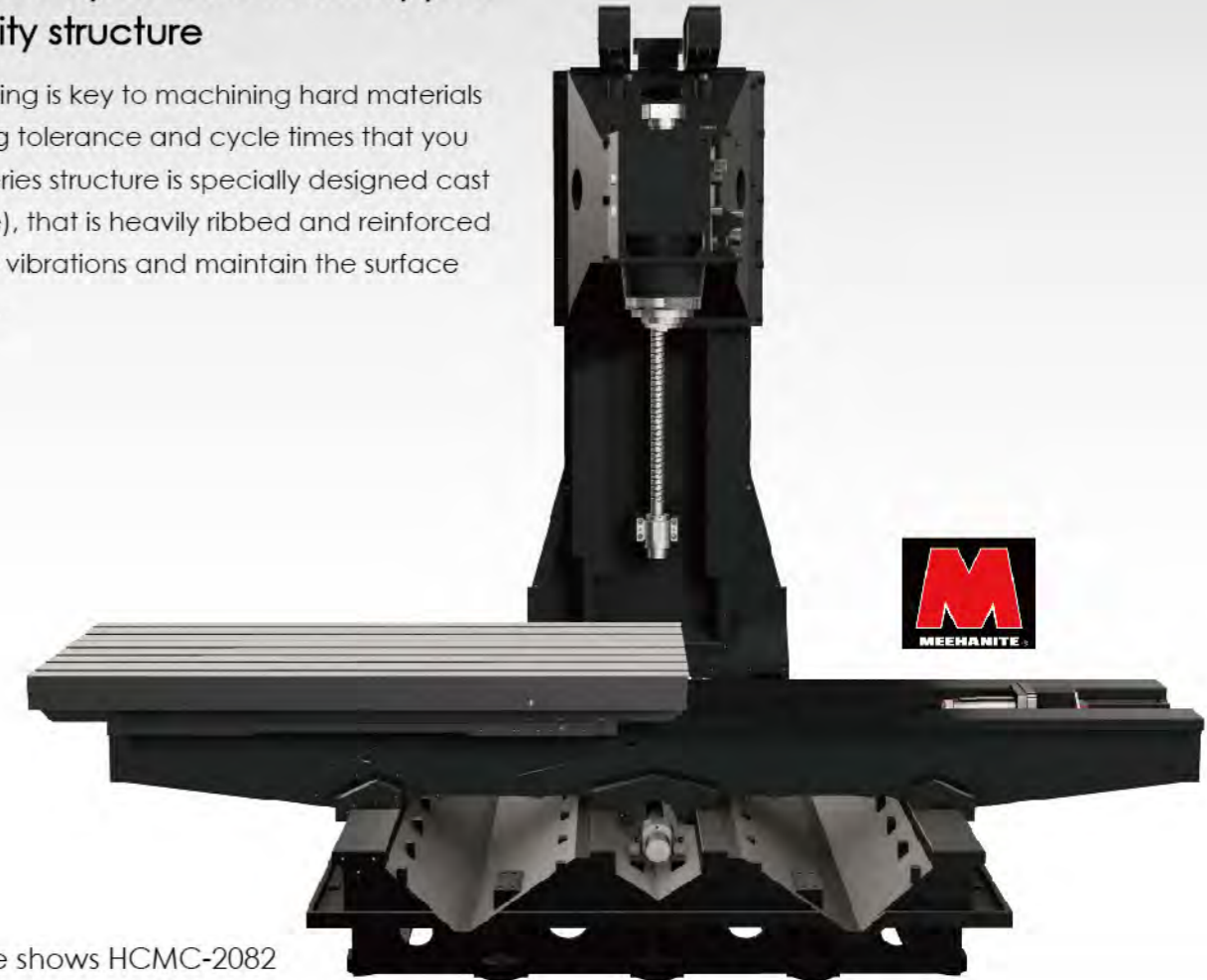

The picture shows HCMC-2082



Full range of box guideway five-year warranty

The following situation is not covered under warranty

1. Improper operation (collision)
2. No regular cleaning of accumulated debris causes damaged to the track.

HCMC-1100, the Machine Equal to Japanese

A+ structural stability

- The increased width of the interface between the column and base by adding A+ support sections.
- Enhanced stability and efficient force dissipation.



New square section resists torsion

- Higher rigidity column.
- Ensure even distribution of cutting forces.
- Enhanced resistance to torsional forces that could impact machining precision.

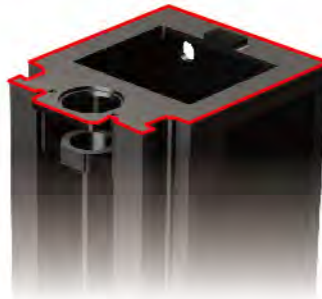

Extra wide stable design

- The original width of the machine feet has been widened to 180mm.
- Delivering a much more rigid and stable platform for heavy machining.



8,000 rpm Gear type spindle

- Two-step gear transmission.
- Spindle run-out : 5 micro
- Available for HCMC all models.



Axis overhand

- The base has been redesigned to widen the support points on the base.
- Guarantee full support throughout the X axis traverse.
- Eliminating with overhand, especially on heavier work piece.



One-piece design for spindle housing and casting iron

- Increases rigidity and cutting performance.
- Reducing weight to reduce acceleration stresses and increase positional accuracy.
- The structural of the head has been adjusted.
- Provide additional support for the spindle to absorb the cutting forces.



Self-made gear driven spindle head

- Two-step speed for transmit
- Low speed with great force output
- Perfect for heavy cutting
- High speed cutting for die & mold industry.



Variety of Hartford Made Spindle Have Quality Assurance

Spindle type

- #40 Gear type 6000 rpm opt. 8000 rpm (HCMC-1100/1365)
- #40 DDS type 10000rpm opt.15000rpm(HCMC-1100/1365)
- #50 Gear type 6000 rpm opt. 8000
- #50 DDS Type 10000/12000 rpm

Spindle torque diagram

Mitsubishi

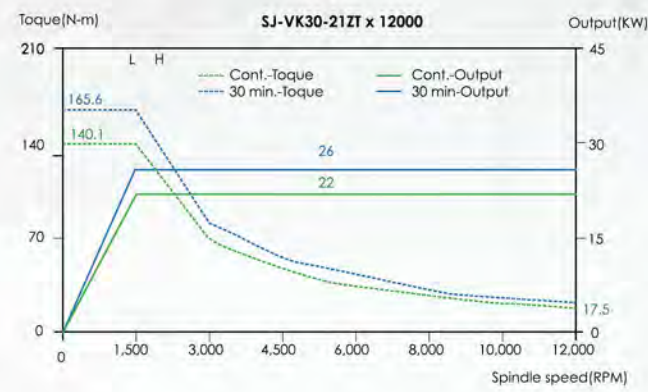
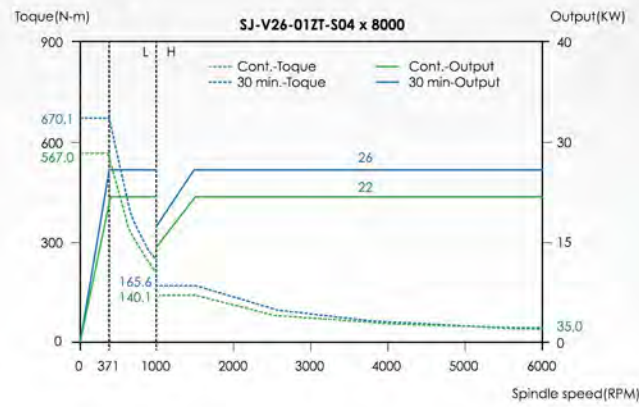

Fanuc

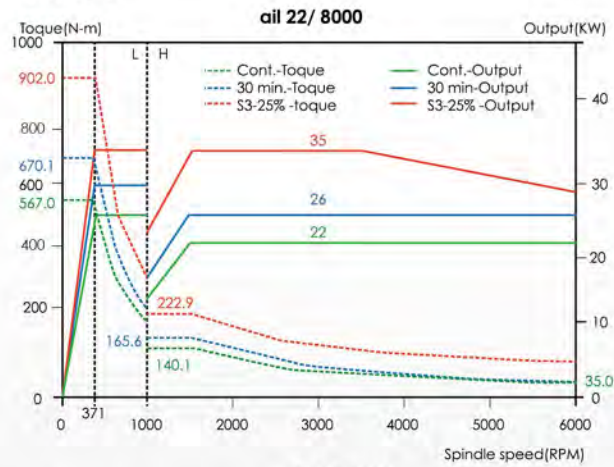

Heidenhain

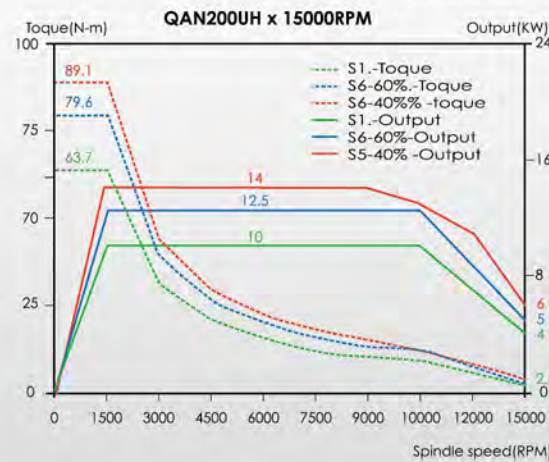
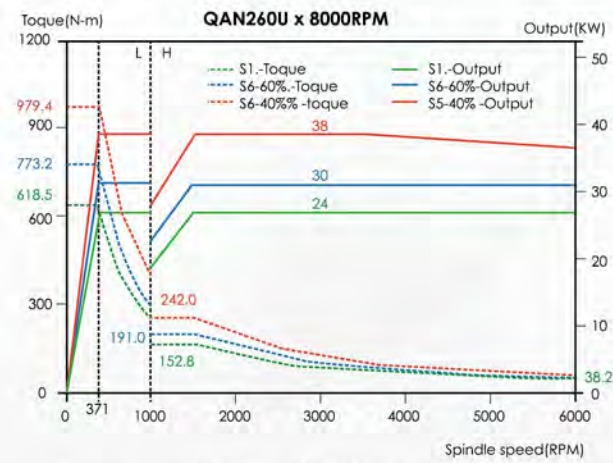

Machine Dimensions

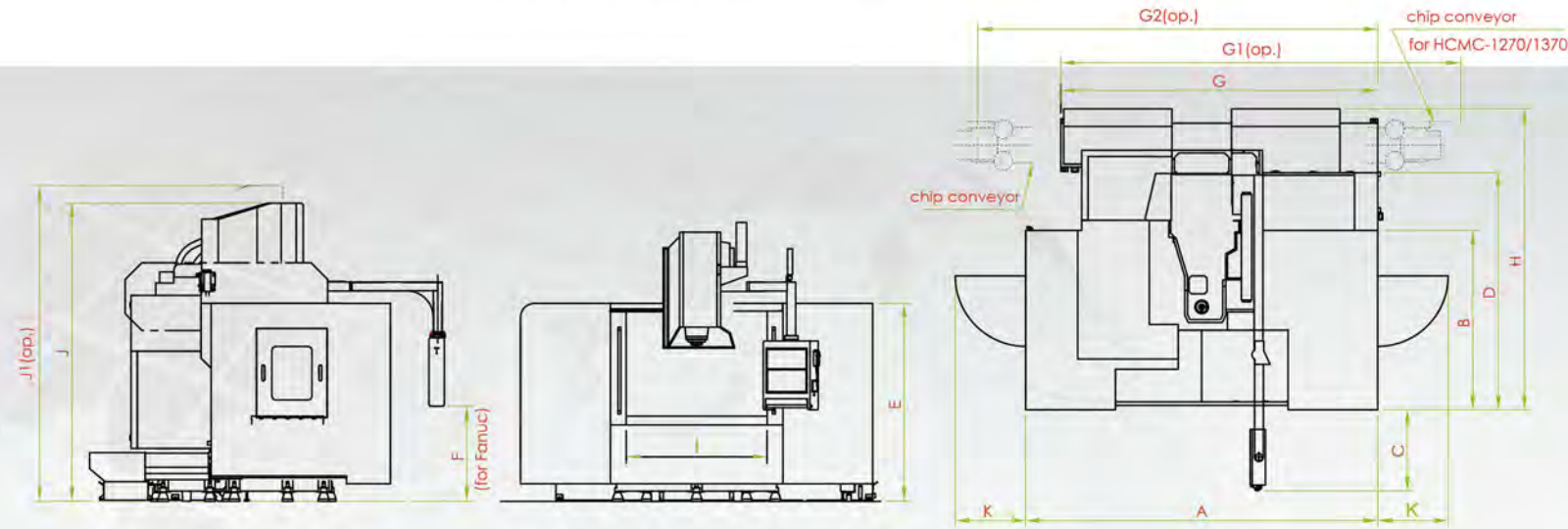

Model	Unit	A	B	C	D	E	F	G	(OP) G1	(OP) G2	H	I	J	(OP) J1	K
HCMC-1365(#40)	mm	3300	1655	880	2265	2200	1080	3450	4400	-	3120	1350	3000	3200	800
HCMC-1365(#50)		3300	1655	880	2265	2200	1080	3450	4400	-	3120	1350	3150	3350	800
HCMC-1370		3300	1609	921	2265	2200	1080	3450	4243	-	3215	1370	3128	3228	800
HCMC-1682		4000	2037	1060	2692	2250	1080	3600	-	4620	3417	1600	3380	3590	800
HCMC-2082		5000	2037	1060	2692	2250	1080	3600	-	4620	3417	2160	3380	3590	800
HCMC-2110		5000	2503	941	3158	2425	1080	3700	-	4720	4009	2100	3450	3650	1000

HCMC-1100

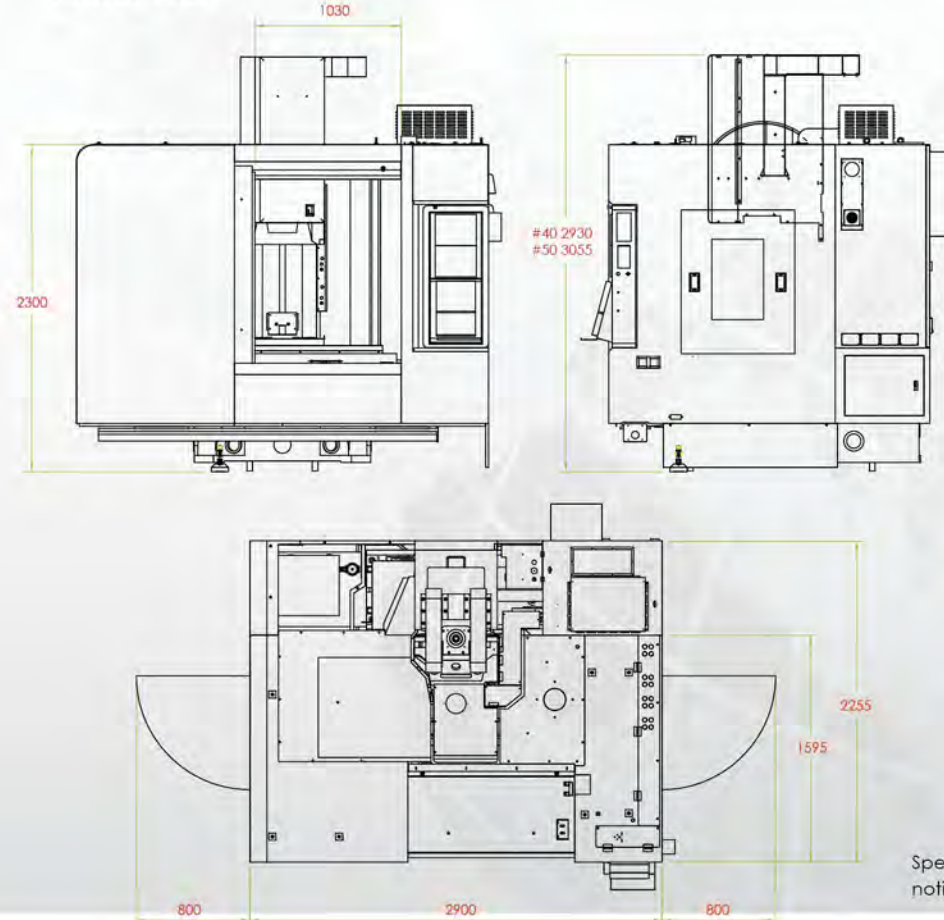

Specifications of the machine are subject to be modified without prior notice, please check with sales staff for detail information.

Machine Specifications

Model	unit	HCMC-1100	HCMC-1365	HCMC-1370	HCMC-1682	HCMC-2082	HCMC-2110	
Table	Working surface	mm	1270x600	1400x650	1450x700	1750x820	2250x1020	
	T-slot Width X pitch(number)	mm	18x120(5)	18x130(5)	18x130(5)	18x150(5)	20x150(7)	
	Max. load (Average)	kg	1200	1200	1500	2200	2600	3000
Travel	X-axis travel	mm	1100	1300	1300	1600	2060	2100
	Y-axis travel	mm	600	650	700	820	820	1020
	Z-axis travel	mm	630	630	660	660 opt. 820	660 opt. 820	820
	Distance from spindle to table	mm	100~730	120~750 opt.320~950	120~780 opt.320~980	150~810 opt.200~1020	150~810 opt.200~1020	200~1020 opt. 400~1220
	Distance from spindle center to column	mm	645	695	745	865	865	1080
Spindle	Spindle nose taper	rpm	#40 / #50	#40 / #50	#50	#50	#50	#50
	Spindle speed(Pulley)	rpm	#40: 8000/10000/12000	#40 : 8000/10000/12000	-	-	-	-
	Spindle speed(Gear)	rpm	#40/#50: 6000 / 8000	#40/#50 : 6000 / 8000	4000/6000/8000	4000/6000/8000	4000/6000/8000	4000/6000/8000
	Spindle speed(DDS)	rpm	#40:10000/15000;#50:10000/12000	#40:10000/15000 ; #50:10000	10000 / 12000	10000 / 12000	10000 / 12000	10000 / 12000
Feed	Cutting feedrate(X/Y/Z)	m/min	12/12/12	12/12/12	12/12/12	12/12/12	12/12/12	10/10/10
	Rapid traverse rate(X/Y/Z)	m/min	24/24/20	#40:24/24/20;#50:24/24/20	24/24/20	20/20/18	18/18/18	15/15/15
ATC	Capacity	pcs	#40:A:24 (30/40);#50A:24 (32)	#40: A:24 (30/40); #50:A:24 (32)	A:24 (40)	A:24 (32/40)	A:24 (32/40)	A:24 (32/40)
	Max. tool weight	kg	#40:7 ; #50:15	#40: 7; #50:15	20	20	20	20
	Max. tool size(dia.X length)	mm	#40: A:Ø75x300L ;#50A:Ø105x300L	#40:A:Ø75x300L; #50A:Ø105x300L	A:Ø125x350L	A:Ø125x350L	A:Ø125x350L	A:Ø125x350L
	Tool shank		BT40(CAT/DIN/BBT); BT-50(CAT50/DIN69871/BBT50)	BT40(CAT/DIN/BBT); BT50(CAT/DIN/BBT)	BT50(CAT/DIN/BBT)	BT50(CAT/DIN/BBT)	BT50(CAT/DIN/BBT)	BT50(CAT/DIN/BBT)
	Pull stub bolt		P40T-1 (CAT40/DIN69872); P50T-1 (CAT-50 / DIN69872)	P40T-1 (CAT40/DIN69872); P50T-1 (CAT50/DIN69872)	P50T-1 (CAT50/DIN69872)	P50T-1 (CAT50/DIN69872)	P50T-1 (CAT50/DIN69872)	P50T-1 (CAT50/DIN69872)
Motor	Spindle drive motor (cont./30 min)	kw	#40:7.5/11 opt. 11/15, 15/18.5; #50:11/15 opt. 15/18.5	#40: 7.5/11 opt. 11/15, 15/18.5; #50:11/15 opt. 15/18.5	7.5/11 opt. 15/18.5 / 22 / 26	11/15 opt.15/18.5/22/26	11/15 opt.15/18.5/22/26	15/18.5 opt.18.5/22/26
Positioning Accuracy	Positioning accuracy (JIS B6330), without linear scale	mm	±0.010	±0.010	±0.010	±0.010	±0.012	±0.012
	Repeatability (JIS B6330), without linear scale	mm	±0.003	±0.003	±0.003	±0.003	±0.003	±0.003
	Positioning accuracy (JIS B6330), with linear scale	mm	±0.008	±0.008	±0.008	±0.008	±0.008	±0.010
	Repeatability (JIS B6330), with linear scale	mm	±0.003	±0.003	±0.003	±0.003	±0.003	±0.003
	Positioning accuracy (VDI 3441)	mm	0.022	0.024	0.024	0.024	0.030	0.030
	Repeatability (VDI 3441)	mm	0.010	0.012	0.012	0.012	0.016	0.016
	Required air pressure	kg/cm ²	6.5	6.5	6.5	6.5	6.5	6.5
	Electric power requirement	KVA	#40:15~40 ; #50:25~40	20~40	25~55	25~55	25~55	30~50
Other	Machine weight	kg	8000	#40:7350 ; #50:7600	9000	11300	12900	16200
	Coolant tank(standard)	L	283	340	340	390	390	480
	Machine dimension(LxWxH)	mm	#40 : 2900 x 2255 x 2917; #50 : 2900 x 2255 x 3057	#40 : 3300 x 2265 x 3000 ; #50 : 3300 x 2265 x 3150	3300 x 2265 x 3128	4000 x 2692 x 3380	5000 x 2692 x 3380	5000 x 3638 x 3450
	Floor space (standard tank)	mm	4500 x 3596	3450 x 4000	3450 x 4136	4000 x 4477	5000 x 4477	5000 x 4950

Standard & Optional Electrical Functions

Hartrol / Standard

- Workpiece Calibration by MPG Directly
- Tool Magazine Display
- Parameter Package

- Threading Cutting (Only for Oi & 31i)
- Monitoring of Tool Status (Only for Oi & 31i)
- Character Caving Macro

Hartnet / Optional

- Management System of Utilizaion
- Machining Time Countdown
- Convenient File Transfer
- Production Management

Electrical Function / Optional

- Compensation of Temperature Displacement
- Retraction for Rigid Tapping
- HMI for Tool Magazine

VDI 3441 accuracy available upon order request.

Specifications & dimensions are subject to change without notice
 (for actual weight, shipped product shall prevail.)